

### Passiv-Verteiler M8 steckbar

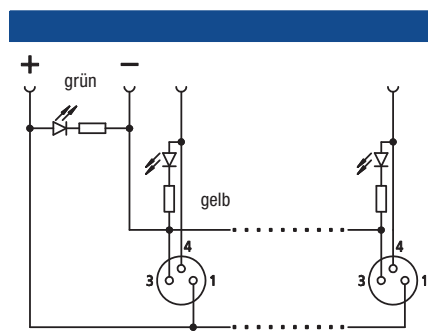



#### Technische Information

Produktbeschreibung		
Bestellbezeichnung	ASBSM... LED	SBS 4/LED
	 	 
Beschreibung	ASB-S steckbarer Miniatur-Aktor-/Sensor-Verteiler mit LED-Betriebs- und Funktionsanzeige, 4- bis 10-fach, M8-Buchse, 3-polig, 1 Signal pro Buchse, M12-Steckverbindung für die Zuleitung, 12-polig	ASB-Classic steckbarer Miniatur-Sensor-Verteiler, mit LED-Betriebs- und Funktionsanzeige, 4 x M8-Buchse, 3-polig, 1 Signal pro Buchse, M12-Steckverbindung für Zuleitung, 8-polig
Technische Daten		
Umgebungstemperatur	-25 °C bis +70 °C	
Gehäusematerial	PBT	TPU, selbstverlöschend
Kontaktträger	PA, selbstverlöschend	TPU, selbstverlöschend
Kontakt	CuZn, unternickelt und vergoldet M8, M12	
Mechanische Daten		
Schutzart	IP67	
Elektrische Daten		
Durchgangswiderstand	≤ 5 mΩ	
Nennspannung	10 bis 30 V DC	
Nennstrom	1,5 A pro Steckplatz/1,5 A max. gesamt	2 A pro Steckplatz/2 A max. gesamt
Lieferumfang		
M8-Schutzkappen	2 Stück	
Beschriftungsschilder	4-fach: 5 Stück 6- bis 8-fach: 10 Stück 10-fach: 15 Stück	1 Stück

#### Schaltbild ASBSM... LED



#### Pinbelegung ASBSM... LED

4-fach	6-fach
 <p>1 = 1 (+) 3 = 2 (-) 4 = 3 (1) 4 (2) 6 (3) 8 (4)</p>	 <p>1 = 1 (+) 3 = 2 (-) 4 = 3 (1) 4 (2) 6 (3) 8 (4) 5 (5) 9 (6)</p>
8-fach	10-fach
 <p>1 = 1 (+) 3 = 2 (-) 4 = 3 (1) 4 (2) 6 (3) 8 (4) 5 (5) 9 (6) 7 (7) 10 (8)</p>	 <p>1 = 1 (+) 3 = 2 (-) 4 = 3 (1) 4 (2) 6 (3) 8 (4) 5 (5) 9 (6) 7 (7) 10 (8) 11 (9) 12 (10)</p>

**Pinbelegung SBS 4/LED**

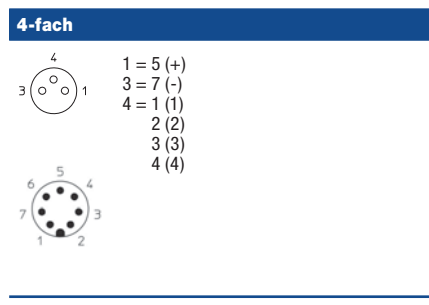

**Schaltbild SBS 4/LED**

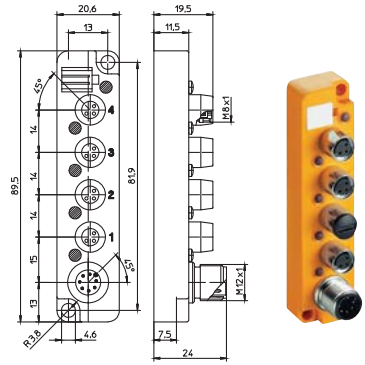
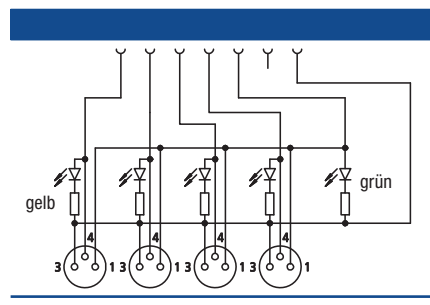

SBS 4/LED

**Bestellinformation**

Bestellinformation	Ausführung
ASBSM 4/LED 3	4-fach
ASBSM 6/LED 3	6-fach
ASBSM 8/LED 3	8-fach

Bestellinformation	Ausführung
ASBSM 10/LED 3	10-fach
SBS 4/LED 3	4-fach

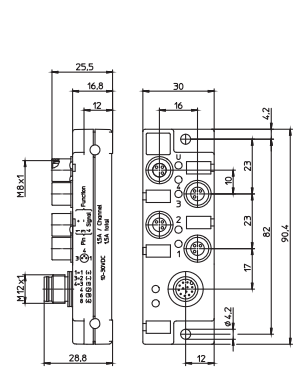

ASBSM 4/LED

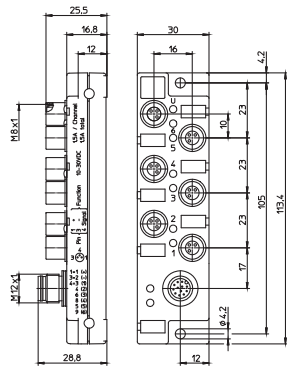

ASBSM 6/LED

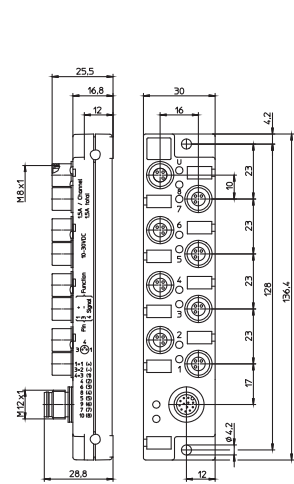

ASBSM 8/LED

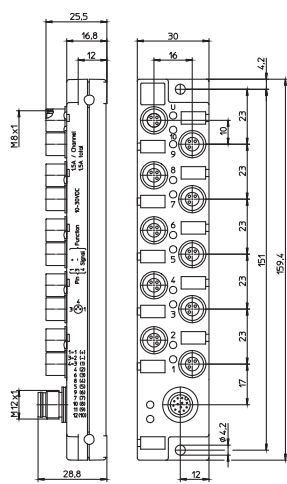

ASBSM 10/LED

